



***T200E SERIES WINDOW***



# T-200E/T-325E SERIES

## T-200E/T-325E SERIES THERMAL-IMPACT CASEMENT, AWNING, HOPPER (OPTIONAL) (AVAILABLE AS FIXED, IN SWING OR OUT SWING)



Bridgehampton, NY – Bates-Masi Architects

MULTIPLE CONFIGURATIONS AVAILABLE

VISIT OUR WEBSITE AT: [WWW.ARCADIAINC.COM](http://WWW.ARCADIAINC.COM) FOR THE FOLLOWING:

Product Specifications (PDF) • Elevations & Plan Details (PDF & DWG) • Product Warranty Information (PDF) • Maintenance & Cleaning Guidelines (PDF) • Product Installation Manuals (PDF)

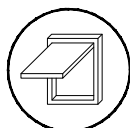

Awning

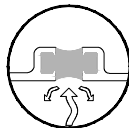

Thermal

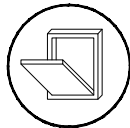

Hopper



Impact



Casement

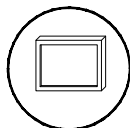

Fixed

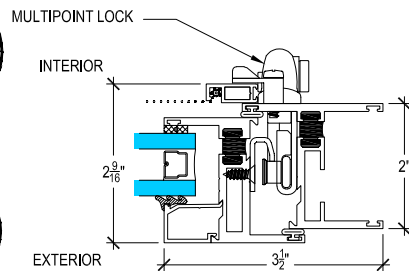

LATCH JAMB

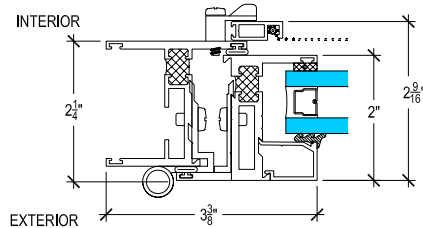

HINGED JAMB

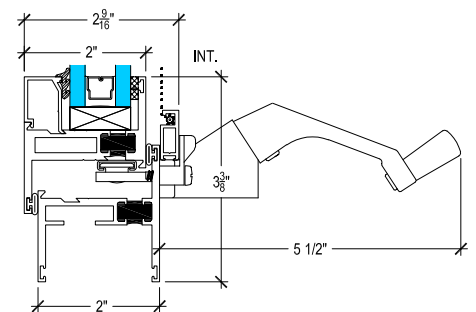

SILL

# T-200/T-325 SERIES

## FEATURES AND OPTIONS

- T200E is a 2" deep frame system
- T325E is a 3 1/4" deep frame system
- Tested performances as HC rated product
- Low air & water infiltration performance - full thermal frame and panel construction
- Long equal leg, short leg, unequal leg & nail fin framing available - 2" depth framing
- Long equal leg framing available - 3 1/4" depth framing
- Can be configured as an awning (project out), hopper (project in), casement (both project in/out) and fixed picture window
- Casement configuration available standard with color matched custom butt hinges
- Project out awnings & project in hoppers available standard with stainless steel 4-bar hinges
- Fixed screen with clip on mounting brackets are available
- Fixed transoms as well as sidelights available to mate with operable windows
- Roto gear operator with fixed arm available on all casements and awnings - optional
- Casement locks and Cam operating handle locks standard
- Multi point locking hardware for casement window - optional
- Casement locks for awning window mounted on both sides of the frame - optional
- Hopper windows come standard with cam handles
- Can be glazed with interior or exterior stops to accommodate 1" IG Glass
- Stock finishes: dark bronze or satin clear anodized class 1 or Duracron paint white - standard
- Any Duranar or Valspar finish or other anodized finish - optional
- **Can be made to meet impact rated hurricane codes - optional**

FEATURES



Southampton, NY, Stelle, Lomont - Rouhani Architects

# T-200E/T-325E SERIES

## T-200E/T-325E SERIES HARDWARE AND OPTIONS



Casement w/ Roto Gear Handle  
and Casement Lock



Casement w/ Roto Gear Handle  
and Multi Point Lock

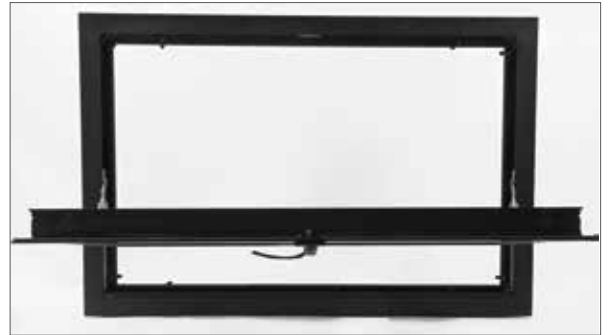

Hopper (Project-in)  
In Open Position with Cam Handle



Awning (Project Out) with Pivot Shoe Roto Operator  
and Casement Lock



Hopper (Project-in)  
In Closed Position with Cam Handle

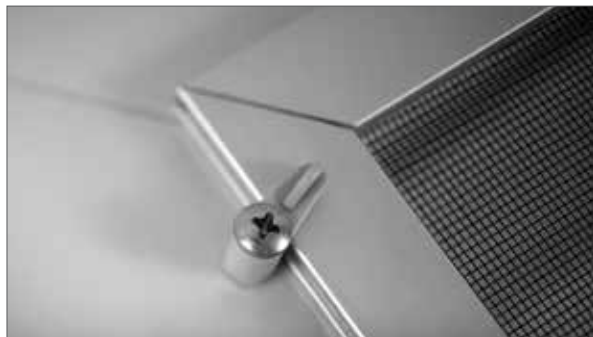

Fixed Window Screen  
Mounting Clips

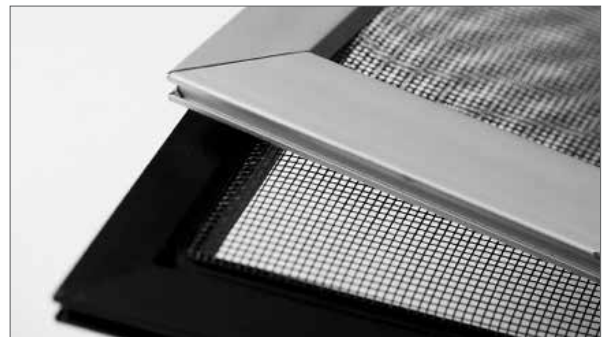

Optional Fixed Window Screen



Contour Roto Operator by Truth Hardware- Optional

# T-200E/T-325E SERIES

## HARDWARE AND OPTIONS



New Style (3) Butt Hinge



Old Style (5) Butt Hinge



4 Bar Stainless Steel Hinge

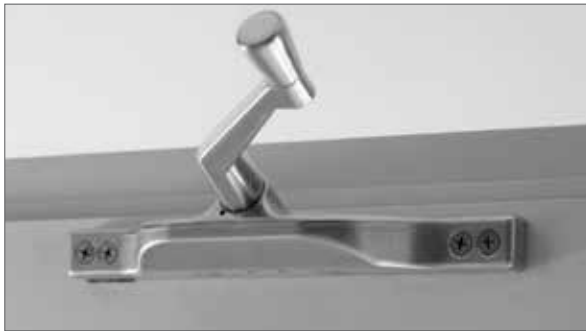

Pivot Shoe Roto Operator (Awning)



Left or Right Handed Roto Operator (Casement)



Long Equal Leg Frame



Short Equal Leg Frame



Nail Fin Frame



Multi Point Lock Handle - Optional



Casement Handle Lock



Cam Handle

HARDWARE





Sag Harbor, NY - Blaze Macoid Architects





Sag Harbor, NY – Blaze Macoid Architects



Southampton, NY, Stelle, Lomont - Rouhani Architects

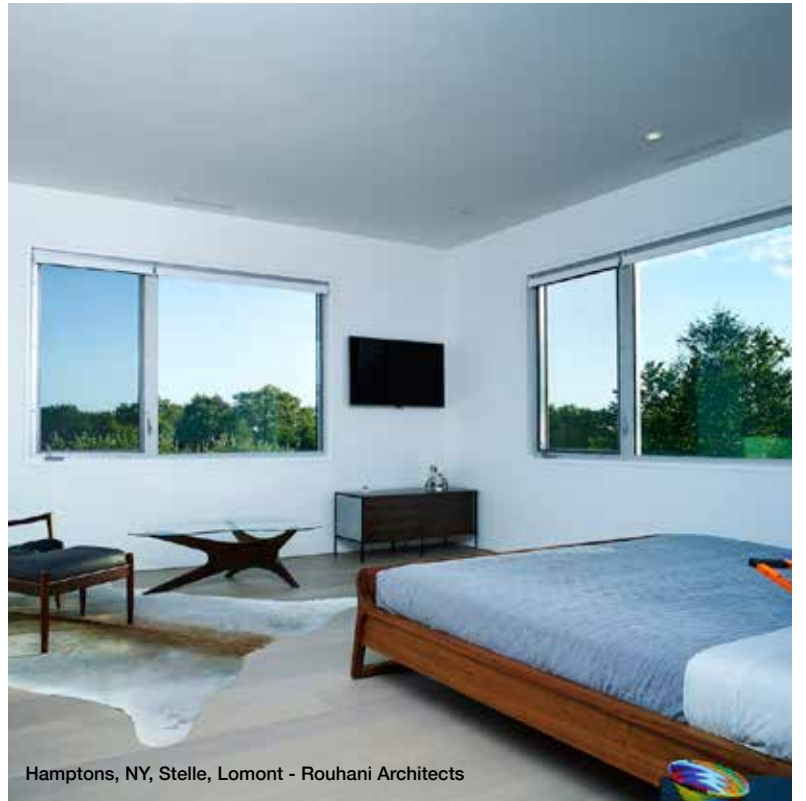

Hamptons, NY, Stelle, Lomont - Rouhani Architects





4 Seasons Resort, Orlando, FL - HKS Architects



Shelter Island, NY - Stelle Lomont Rouhani Architects

LEEDS CERTIFIED



HURRICANE IMPACT RESISTANT DOORS & WINDOWS



FIND US / LIKE US ON



arcadia